

HSDPA Overview and Development of Radio Network Equipment

*Yoshikazu Goto, Hideyuki Matsutani,
Hidehiko Ooyane and Kenji Fukazawa*

The HSDPA service commenced in August 2006 was developed aiming at greater speed, lower cost and reduced delays of W-CDMA. This article describes the technical characteristics of HSDPA, and the development of functions for the radio network equipment.

1. Introduction

The W-CDMA-based FOMA service was first introduced in Japan in October 2001. The number of FOMA service subscribers exceeded the number of PDC subscribers in June 2006, and had reached 28,000,000 by August 2006. This number is expected to further increase in a smooth transition towards the Third-Generation mobile communication system. The diffusion of IP technology such as the Internet has led to a rapid increase in demand for packet transmission in a variety of communication services, while simultaneously increasing demand for reduced communications charges.

Under these circumstances, High Speed Downlink Packet Access (HSDPA) satisfying demands for cost reduction, increased speed, and reduced delays has become standardized [1] in a 3rd Generation Partnership Project (3GPP) [2], and DoCoMo launched a commercial HSDPA service in August 2006. The objectives of introducing HSDPA were to increase cell throughput (for increasing the number of subscribers per cell and reducing the equipment cost per bit of information),

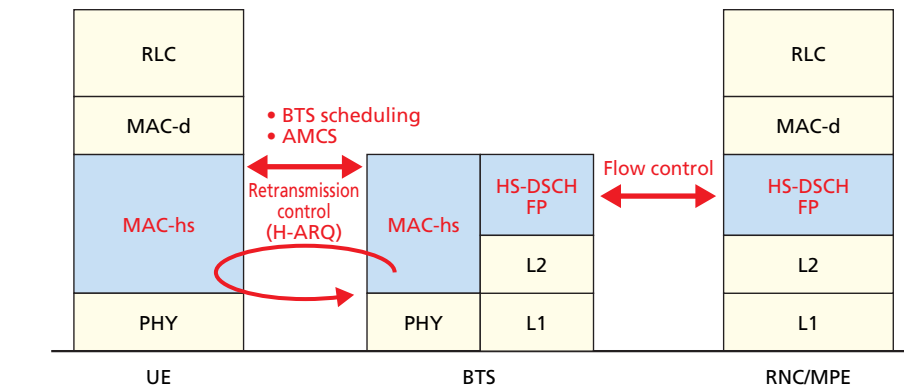

HS-DSCH FP (Frame Protocol): Transmission protocol for user data between RNC and BTS mapped to HS-DSCH.

Figure 1 Protocol stack and technical characteristics

increase user throughput (for increasing bit rate), and reduce delays.

This article describes the technical characteristics of HSDPA newly developed in radio network equipments, and the methodology for implementing functions in the Base Transceiver Station (BTS), Radio Network Controller (RNC)^{*1}, and Multimedia signal Processing Equipment (MPE)^{*2}.

2. HSDPA Characteristics

Figure 1 shows the protocol stacks and technical characteristics for the equipment used in HSDPA. With HSDPA, the use of Medium Access Control-HSDPA (MAC-hs)^{*3} retransmission control, BTS scheduling, and Adaptive Modulation and Coding Scheme (AMCS) serves to reduce transmission delays, improve the radio usage efficiency, and increase bit rate over the radio channel between a BTS and a mobile terminal (User equipment: UE) [3]. Furthermore, since the bit rate over a radio channel varies with HSDPA, flow control is adopted between the MPE and BTS in order to send data in response to this variation in rate. Thus, the operation appropriate for cell change used with HSDPA is also possible. Each of these technologies is outlined below.

2.1 MAC-hs Retransmission Control

In addition to Radio Link Control (RLC)^{*4} retransmission control adopted between the MPE and UE used with W-CDMA,

the introduction of MAC-hs retransmission control between the BTS and UE reduces transmission delays. Furthermore, by synthesizing data resent from the BTS using Hybrid Automatic Repeat reQuest (H-ARQ)^{*5} with data previously received but not able to be decoded, decoding becomes possible with fewer retransmissions than with ARQ used with RLC retransmission control, thus providing improved reception quality and greater transmission efficiency.

2.2 BTS Scheduling and AMCS

Figure 2 shows BTS scheduling and AMCS. While W-CDMA allocates a Dedicated Physical CHannel^{*6} (DPCH) to each user, with HSDPA, a High Speed-Physical Downlink Shared CHannel (HS-PDSCH) is shared by multiple users, and BTS scheduling is done to select users for allocation at 2-ms intervals in response to the radio environment of each user. By selecting users with relatively good radio environments each 2-ms interval, cell throughput is improved compared with random allocation irrespective of the radio environment, thus increasing the radio usage efficiency.

Furthermore, while W-CDMA performs transmission power control in response to variations in the radio environment, to achieve a specified reception quality while maintaining a fixed transmission rate. Conversely, with HSDPA, the transmission power is fixed, and transmission rate is variable by using AMCS adopted to adaptively vary the modulation method, cod-

*1 RNC: A device defined by 3GPP for performing radio circuit control and mobility control in the FOMA network.

*2 MPE: An equipment used for packet retransmission control and voice coding on the FOMA network. Under 3GPP, functions regulated as being conducted on the RNC are grouped to be conducted on MPE, an equipment physically separate from the RNC.

*3 MAC-hs: A sub-layer protocol of Media Access Control (MAC) for HSDPA. Used to perform flow control, the prioritizing of transmission, sequence assurance control, and data retransmission control, etc.

*4 RLC: Data link layer protocol for W-CDMA, performs data retransmission control, etc.

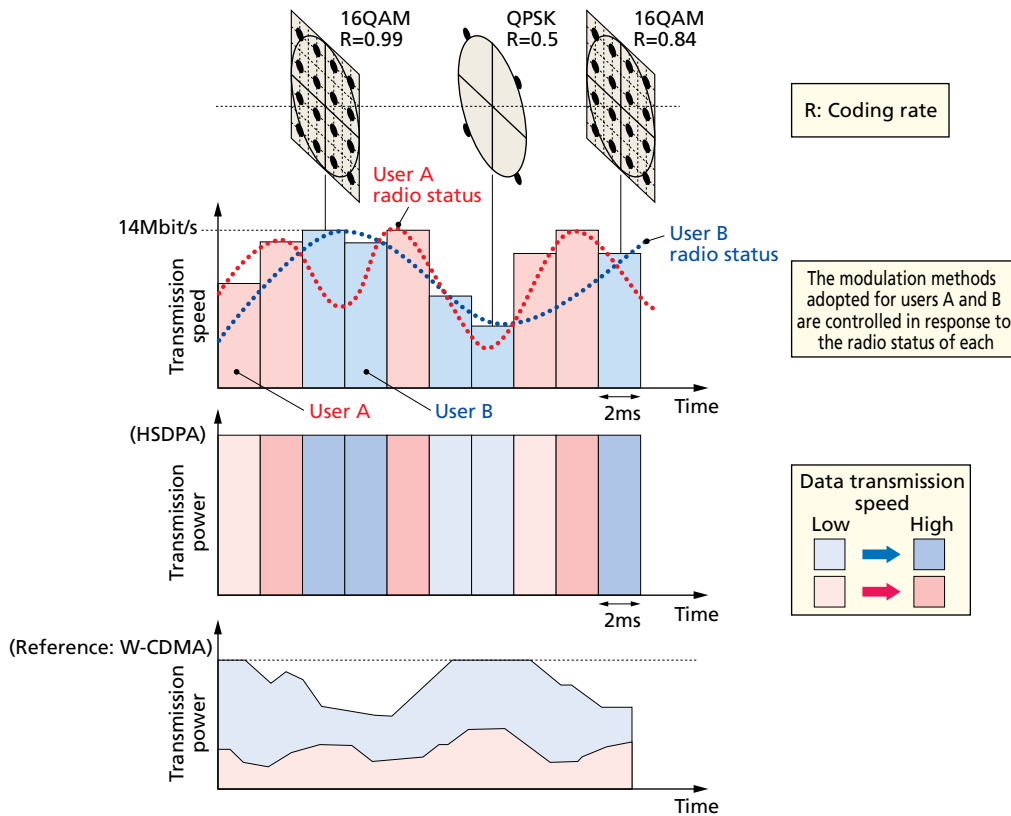

QPSK (Quadrature Phase Shift Keying): A digital modulation method in which four-valued information is associated with four phase statuses.

Figure 2 Overview of BTS scheduling and AMCS

ing rate, and the number of codes according to the radio environment. High-speed AMCS (in a minimum 2-ms cycle) permits a transmission rate in response to the radio environment, achieves increased bit rate, and improves the radio usage efficiency.

2.3 Flow Control

With HSDPA, AMCS is adopted to vary radio bit rate in response to the radio environment, and since HS-PDSCH is also adopted, radio bit rate for each user is varied in response to the number of simultaneous connections. Flow control is therefore performed to ensure that data transmission between the MPE and BTS tracks variations in bit rate over the radio channel. If flow control is not used appropriately and transmission rate between the MPE and BTS exceeds the radio bit rate, signals exceeding the radio bit rate flow into the MAC-hs function unit

of BTS, thus increasing the signal dwell time in the BTS. When the signal dwell time in the BTS becomes excessive, all data in the BTS buffer can no longer be sent at the Serving High Speed-Downlink Shared CHannel (HS-DSCH) Cell Change, and data is lost. Section 3.3 below describes this phenomenon. On the other hand, when the volume of signals flowing into the MAC-hs function unit of BTS is less than the radio transmission capability, transmission data in the BTS is depleted, and the radio usage efficiency deteriorates.

Since HSDPA has a high transmission rate, signals may be lost if sufficient bandwidth is not available on a cable transmission route between the MPE and BTS, in which case flow control is also consequently performed as appropriate for the bandwidth of the transmission route.

Figure 3 shows flow control. Two control signals have been added to realize flow control: the Capacity Allocation sig-

*5 H-ARQ: Technology combining Automatic Repeat reQuests (ARQ) and error correction codes to increase error correction capacity during repeats, and reduce the number of repeats.

*6 Physical channel: Channel classified by physical resources (e.g. frequencies) in the radio interface.

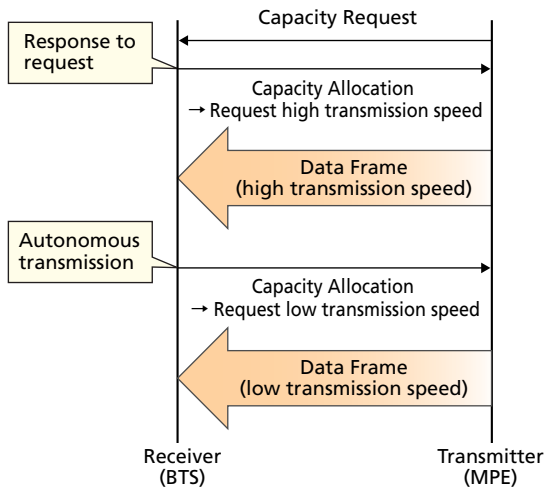

Figure 3 Outline of flow control

nal used by the receiver (BTS) to specify the transmission rate for the transmitter (MPE), and the Capacity Request signal used by the transmitter to request the Capacity Allocation signal from the receiver. When the data dwell time in the BTS buffer of the receiver is short, high-rate transmission is requested with the Capacity Allocation signal to prevent the depletion of data in the BTS buffer. When the dwell time is long, low-rate transmission is requested with the Capacity Allocation signal. Then the transmitter sends data at the transmission rate specified by the Capacity Allocation signal.

3. Mobility Control With HSDPA

The following describes the channel configuration, hand-over, and Serving HS-DSCH Cell Change.

3.1 Channel Configuration

Figure 4 shows a channel configuration in which a single UE adopts a radio interface during packet access with HSDPA.

The uplink (from the UE to the network) has the same channel configuration as the one that is adopted during packet access with W-CDMA, and control information is transmitted via a Dedicated Control CHannel (DCCH, a logical channel^{*7}), while user data (packet data, voice, image) is transmitted via a Dedicated Traffic CHannel (DTCH, a logical channel). These channels are each mapped to a Dedicated CHannel (DCH, a transport channel^{*8}), and data is transmitted after multiplexing to a DPCH [4].

Conversely, the downlink (from the network to the UE) has a unique HSDPA channel configuration in which the DTCH transmitting the user data on the downlink is mapped to an HS-DSCH that is a transport channel dedicated to each UE, and mapped to an HS-PDSCH shared between multiple HS-DSCHs on a physical channel. Since downlink control information is sent via a DPCH (a physical channel dedicated to a single user), user data and control information are sent via separate physical

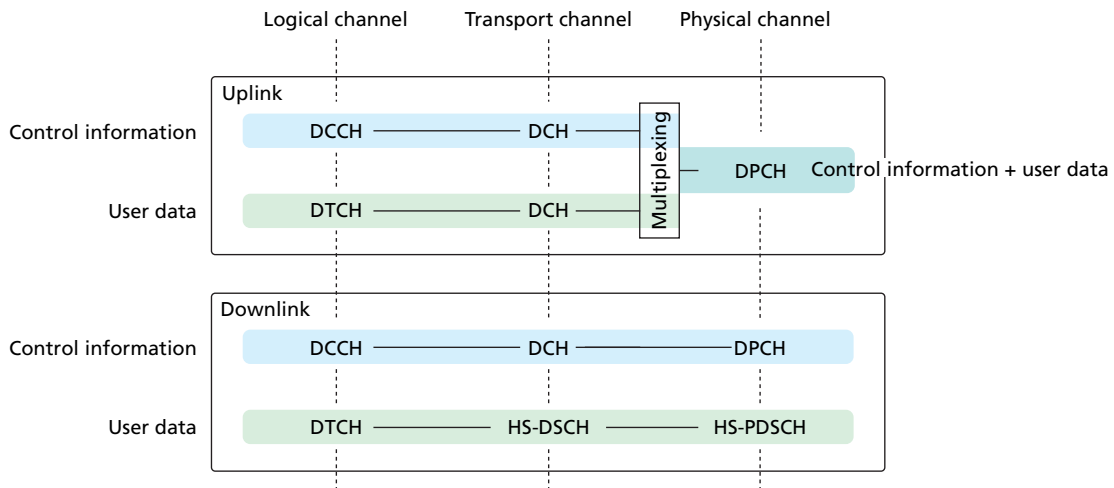

Figure 4 Channel configuration used with HSDPA

*7 Logical channels: Channels classified by the type of information (e.g. user data, control information) that they transmit via the radio interface.
 *8 Transport channels: Channels classified by their transmission characteristics (bit rate, intensity of error correction, etc.) in the radio interface.

channels. A DPCH used with HSDPA is referred to as an Associated-Dedicated Physical CHannel (A-DPCH).

3.2 Handover

Figure 5 shows the handover status during packet access with HSDPA. Data over A-DPCHs is transmitted via multiple Radio Links (RLs)^{*9}, and these RLs transmitting data on A-DPCHs are subject to handover within the base station (Soft HandOver: SHO) and/or handover between base stations (Diversity HandOver: DHO). The RLs transmitting data of a single user on these A-DPCHs and an HS-PDSCH are referred to as an Active Set. Data transmitted via an HS-DSCH is transmitted via an HS-PDSCH on any one RL in an Active Set. While RLs transmitting data on A-DPCHs are subject to SHO and/or DHO within an Active Set in this manner, an RL transmitting data on an HS-PDSCH is not subject to SHO and/or DHO. An RL transmitting data on an HS-PDSCH allocated to the relevant UE is referred to as the Serving HS-DSCH Radio Link.

3.3 Serving HS-DSCH Cell Change

As described in Section 3.2, the Serving HS-DSCH Radio Link is any single RL in an Active Set. To improve user throughput, the RNC provides control to ensure that the RL (within the Active Set) for which the best reception quality is obtained at the UE is the Serving HS-DSCH Radio Link. When the RL within the Active Set providing the best reception quality

changes with movement of the UE, the Serving HS-DSCH Radio Link must therefore be changed to the RL providing the best reception quality. This mobility control is referred to as Serving HS-DSCH Cell Change [1].

Figure 6 shows the Serving HS-DSCH Cell Change sequence. The example shows switching of the Serving HS-DSCH Radio Link from one BTS to another.

When the reception quality of each RL in the Active Set is constantly changing and an RL is replaced with another to ensure the best reception quality, the RL providing the best reception quality is reported from the UE (Fig. 6 (1)). Then the RNC requests setup of an HS-DSCH to the BTS (target BTS) that has the RL providing the best reception quality (Fig. 6 (2)), and requests deletion of the HS-DSCH to the BTS (source BTS) that has the current Serving HS-DSCH Radio Link (Fig. 6 (3)). The RNC then sets up a transport bearer^{*10} between the target BTS setting up the new HS-DSCH and the RNC (Fig. 6 (4)). The RNC then issues an instruction to the target BTS, the source BTS, and the UE to switch the Serving HS-DSCH Radio Link (Fig. 6 (5)). Since switching of the Serving HS-DSCH Radio Link is synchronized among with the target BTS, the source BTS, and the UE, the timing with which switching is executed is reported with the relevant instruction. Furthermore, in order to prevent the loss of user data and consequent deterioration in throughput during switching, when the source BTS receives the relevant instruction, an instruction to temporarily halt the downlink transmission of user data is sent to the MPE using the flow control function described in Section 2.3 (via the Capacity Allocation signal) (Fig. 6 (6)). After switching of the Serving HS-DSCH Radio Link, the UE reports the completion of the switching to the RNC (Fig. 6 (7)). The target BTS then issues an instruction to resume the transmission of user data on the downlink (via the Capacity Allocation signal) (Fig. 6 (8)). Thus, data received by the MPE while the transmission of downlink user data is temporarily halted is also transmitted with the Serving HS-DSCH Radio Link that has been switched to the target BTS. The transport bearer between the source BTS releasing the HS-DSCH and the RNC is then released (Fig. 6 (9)), thus completing the sequence.

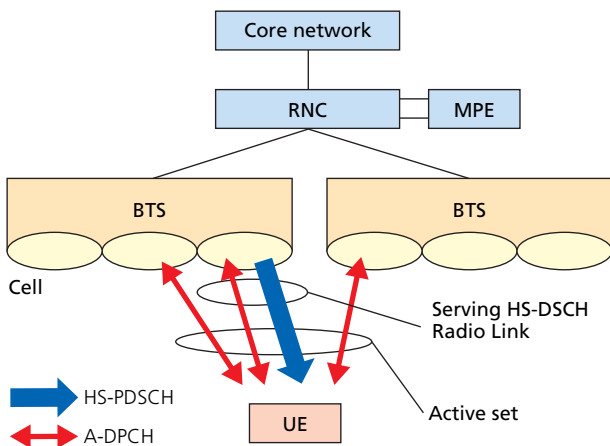

Figure 5 Handover status with HSDPA

*9 Radio Link: A logical link between the mobile terminal and cells (access points in a radio access network).

*10 Transport bearer: A circuit for transmitting user data between nodes.

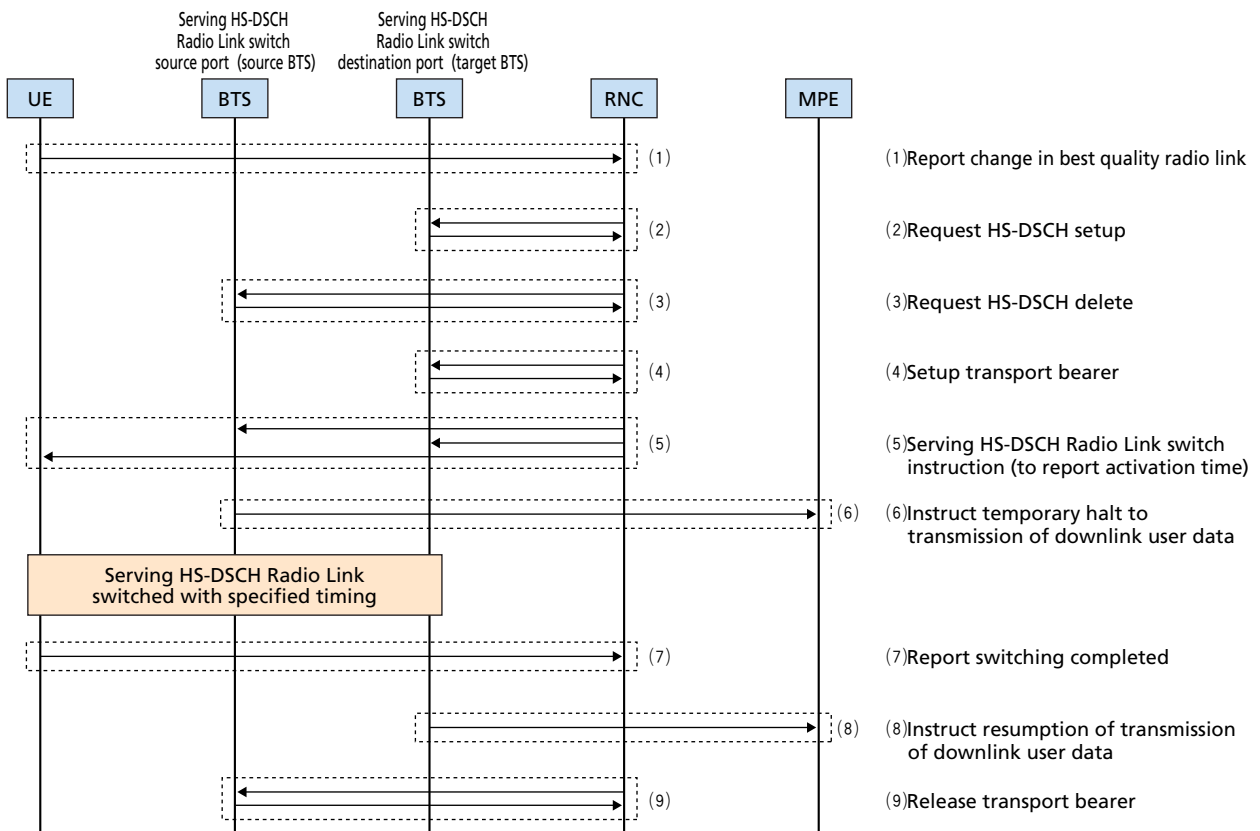

Figure 6 Serving HS-DSCH Cell Change sequence between BTSs

4. Implementation of HSDPA Functions in BTS

When implementing HSDPA service, it is important to provide HSDPA functions (such as HSDPA-related transport channels and physical channels, H-ARQ, AMCS, and flow control) with minimum changes made to existing BTS equipment in order to rapidly and economically expand the HSDPA service area.

The following describes the technology used for realizing HSDPA functions in BTS, and the HSDPA functions of BTS.

4.1 Technology for Providing HSDPA Functions in BTS

This section describes the technology used for providing HSDPA functions for an existing 4-carrier 6-sector BTS [5]. **Figure 7** shows a 4-carrier 6-sector BTS configuration. The 4-carrier 6-sector BTS consists of Modulation and Demodulation Equipment (MDE), a transmission AMPLifier (AMP), an Optical Feeder Transmitter and Receiver (OF-TRX)^{*11}, and a RF Multi-

drop Optical Feeder (MOF)^{*12}, and flexibly adapts to a wide range of conditions, ranging from low to high traffic areas and in indoor and outdoor areas.

In order to implement HSDPA functions with minimum changes to the 4-carrier 6-sector BTS, development was conducted to implement HSDPA functions by only changing the MDE without modifying such equipment as the AMP and OF-TRX connected to the MDE. As a result, HSDPA functions were able to be implemented by simply replacing certain MDE cards, such as the Base Band signal processor (BB) card and the Call Processing CoNTroller (CP-CNT) card.

A number of issues had to be solved in order to implement HSDPA functions by simply replacing certain MDE cards. The major issue was the need to measure HSDPA transmission power at a Transmission Time Interval (TTI)^{*13} of 2 ms. The measurement of transmission power to implement HSDPA entailed measurement of not only total transmission power, but

*11 OF-TRX: Equipment connected to the MDE via optical fiber. Usable with optical fiber at distances up to 20 km.

*12 RF MOF: Equipment that relays RF signals of BTS via optical fiber. Comprised of master and slave stations.

*13 TTI: Transmission time per data item transmitted via a transport channel.

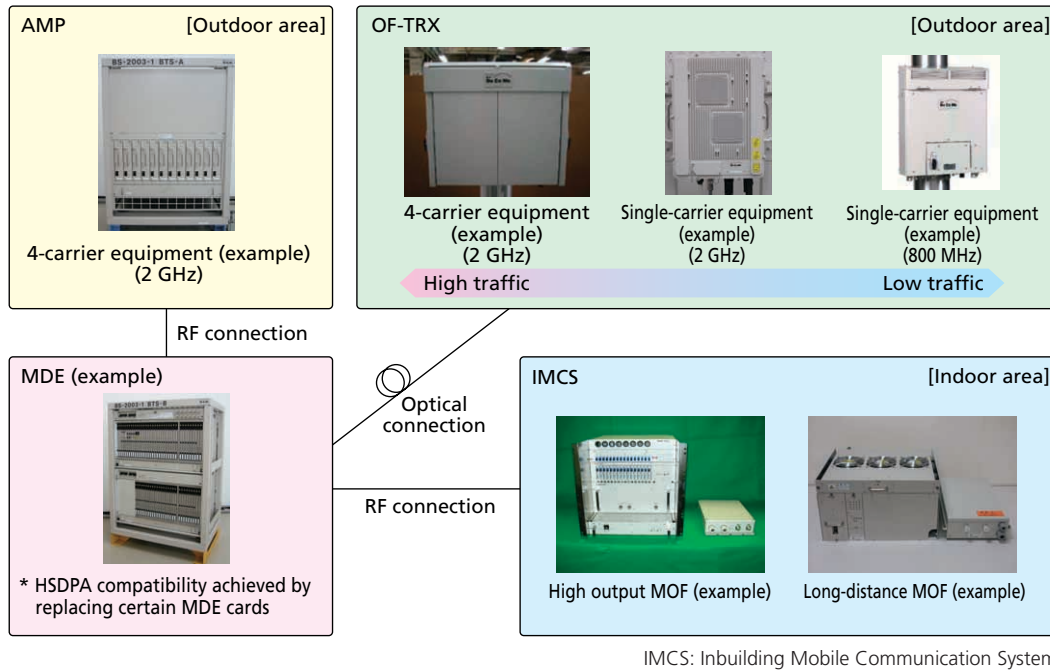

IMCS: Inbuilding Mobile Communication System

Figure 7 Configuration of a 4-carrier 6-sector BTS

also the transmission power used only for HSDPA, and at very short intervals of 2 ms with existing equipment designed for power measurements at intervals of 100 ms. Measuring the transmission power used only for HSDPA required measurement before channel multiplexing, and since measurement at the transmission power termination (the conventional measurement point) proved difficult, measurements were taken directly from the BB card, thus permitting high-speed measurement at the 2-ms TTI. As a result, HSDPA was implemented simply by replacing certain MDE cards without having to replace the existing AMP, OF-TRX, and MOF, thus facilitating early expansion of the HSDPA service area.

Newly developed HSDPA-compatible cards have further facilitated the economical implementation of HSDPA functions. By incorporating a high performance CPU, the HSDPA CP-CNT card has doubled processing capability, at a 40% cost reduction in terms of processing capability per channel. Furthermore, the HSDPA BB card adopts a new Digital Signal Processor (DSP)^{*14} and greater on-chip integration, so that the number of channels able to be processed on a single card has almost doubled, and since existing channels and HSDPA chan-

nels can coexist on the same card, BB resources can be used more effectively. Power consumption per channel has been reduced by approximately 50%, while the cost per channel has been reduced by approximately 30%.

4.2 Basic HSDPA Specifications for BTS

Table 1 shows the basic HSDPA specifications for the BTS. In line with the introduction of HSDPA, radio characteristics are now compatible with 16 Quadrature Amplitude Modulation (16QAM)^{*15} and the modulation accuracy^{*16} satisfies

Table 1 Basic HSDPA specifications for BTS

Modulation method	QPSK, 16QAM
Modulation accuracy	12.5%
Data transmission speed	Approx. 14 Mbit/s maximum
Number of HS-PDSCH codes	Up to 15 codes per carrier sector
Number of HS-SCCH codes	Up to 4 codes per carrier sector
Number of MAC-d Flows	Up to 8 per user
Number of MAC-hs priority queues	Up to 8 per user
Number of H-ARQ simultaneous start process	Up to 8 processes per user
Number of HSDPA users	Up to 96 users per carrier sector

HS-SCCH (High Speed-Shared Control Channel): A control signal channel for specifying the transmission destination UE and modulation method at each TTI in the HS-PDSCH.

*14 DSP: A processor specialized in the processing of audio, video, and other digital signals.

*15 16QAM: A digital modulation method that allows transmission of 4 bits of information simultaneously by assigning one value to each of 16 different combinations of amplitude and phase.

*16 Modulation accuracy: An index indicating the difference from the ideal value when a signal is demodulated.

the 12.5% requirement. HS-PDSCH is able to support up to 15 codes per carrier sector, and applicable to all HS-DSCH physical layer categories (Categories 1–12) defined by 3GPP. Up to 96 HSDPA users may be accommodated per carrier sector, and a transmission rate of up to approximately 14 Mbit/s is possible. In order to ensure compatibility with new services, up to 8 MAC-d Flows^{*17} and MAC-hs priority queues^{*18} may be allocated per user.

In addition to the basic specifications, the BTS has the following supplementary features.

- 1) Following replacement by an HSDPA card, the HSDPA service can be started with limited changes to the system data without having to change the software.
- 2) Channel allocation control is implemented to ensure as far as possible that a spare HSDPA BB card is available, and in case of a card failure, an existing channel and an HSDPA channel are switched at high speed to the spare HSDPA BB card to permit restoration without a break in communication.

5. Implementation of HSDPA Functions in RNC and MPE

As with BTS, the implementation of HSDPA functions in RNC and MPE uses existing equipment as much as possible to ensure rapid and economical expansion of the service area. The HSDPA functions of RNC described in Chapter 3 are mainly implemented in software. The MPE flow control function described in Section 2.3 is also implemented in software. This chapter describes the HSDPA functions of RNC and MPE equipment, and methods of providing these functions.

5.1 RNC

HSDPA functions can be added to the existing RNCs by simply adding a High Speed Data Processing Unit (HSDPU) function unit. The HSDPU function unit is either an HSDPU module or an HSDPU card.

The primary functions of the HSDPU are to receive data frames from the MPE, convert these frames into HS-DSCH data frames, and then send the frames to the BTS, as well as convert-

ing and relaying control signals for flow control between the BTS and MPE (Capacity Allocation signal, Capacity Request signal). The HSDPU function unit has a peak uplink data rate per user of 384 kbit/s, and for the future enhancement, the peak downlink data rate of approximately 14 Mbit/s is possible without hardware modification.

5.2 MPE

HSDPA functions can be added to the existing MPEs by simply adding a Signal Processing Unit for High Speed Packet (SPUHSP). The SPUHSP is a new signal processing card that provides greater processing speed than the existing Signal Processing Unit for VOice/Data (SPUVOD) card. Its functions are to receive the Capacity Allocation signal, a flow control signal from the BTS, control transmission volume of downlink data at the specified transmission speed, and send the Capacity Request signal to the BTS.

The SPUHSP provides increased user capacity per card and a tenfold increase in the data transmission capacity when compared to the existing SPUVOD card. The peak uplink data rate per user is 384 kbit/s, and for the future enhancement, the peak downlink data rate of approximately 14 Mbit/s is possible without hardware modification.

6. Conclusion

This article described the technical characteristics related to the development of HSDPA radio network equipment (MAC-hs retransmission control, BTS scheduling, adaptive modulation and coding, flow control, and mobility control functions), and the methodology adopted to implement HSDPA functions in BTS, RNC, and MPE.

REFERENCES

- [1] 3GPP, TS 25.308 V5.7.0 (2004-12): "High Speed Downlink Packet Access (HSDPA); Overall description; stage 2."
- [2] <http://www.3gpp.org/>
- [3] H. Ishii, A. Hanaki, Y. Imamura, S. Tanaka, M. Usuda and T. Nakamura: "Effects of UE Capabilities on High Speed Downlink Packet Access in W-CDMA System," Proc. of IEEE VTC 2004 spring, Milan, Italy, May 2004.
- [4] S.Onoe et.al.: "Radio Access Network Technologies," NTT DoCoMo

*17 MAC-d Flow: A unit of control for transmitting user data from an RNC to a BTS using an HS-DSCH FP.

*18 MAC-hs priority queue: A transmission queue in the MAC-hs layer. Priority class is defined in each transmission queue.

Technical Journal, Vol.3, No.3, pp.5-15, Dec.2001.

[5] A.Hikuma et.al: "Radio Base Stations Equipments toward Economical

Expansion of FOMA Coverage Areas," NTT DoCoMo Technical Journal,
Vol.6, No.1, pp.52-60, Jun.2004.